



**CUSTOM  
-MADE**  
PROJECTS

**FAIRFAIR**

STANDS | EVENTS | EXHIBITIONS

WHO  
WE

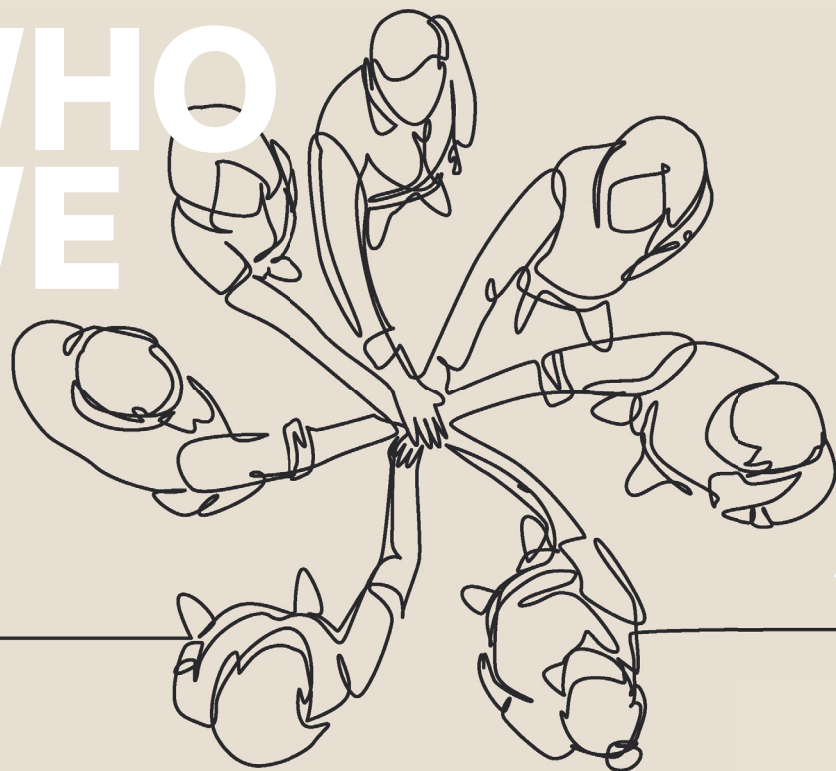

ARE? A PASSIONATE TEAM



**Ghislain Ludwig**  
Director



**Delphine Michel**  
Director & Head of Projects



**Sara Ahktar**  
Head of Projects



**Victor Quinet**  
Technical manager



**Francis Gogan**  
Stock manager



**François Veljkovic**  
Equipment maintenance

# GOALS

LOOKING FOR A PARTNER FOR YOUR  
STANDS | EVENTS | EXHIBITIONS ?

FAIRFAIR IS COMPOSED OF A VERSATILE TEAM THAT **MANAGES**  
**A PROJECT FROM START TO FINISH**, FROM CONCEPTION TO COMPLETION



OUR PROJECT MANAGERS HELP YOU **VISUALIZE YOUR PROJECT**  
FULLY WITH 3D SIMULATIONS, TECHNICAL PLANS,  
AND A DETAILED QUOTE

WE MAINTAIN A 1200m<sup>2</sup> WAREHOUSE OF EVENT EQUIPMENT,  
WHICH IS PREPARED AND SHIPPED TO THE EVENT SITE,  
**WE HANDLE ALL TRANSPORTATION, SETUP & DISMANTLING**



THANKS TO OUR **EXPERTISE IN TRADE FAIRS THROUGHOUT EUROPE**,  
WE OFFER A TURNKEY SERVICE, EVERYTHING  
IS READY UPON YOUR ARRIVAL

# CONCEPT



OVERALL THEME  
COLOR PALETTE  
MATERIAL SELECTION  
FURNITURES

## MATCHING WITH YOUR BRAND

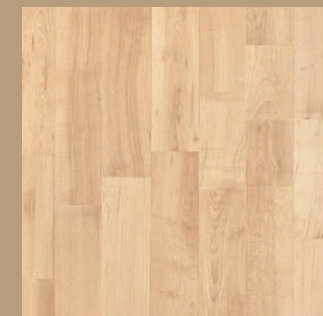
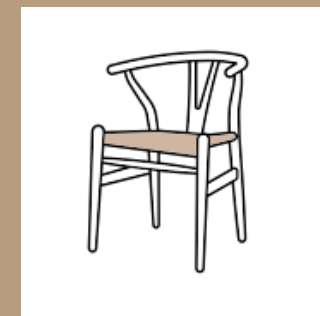
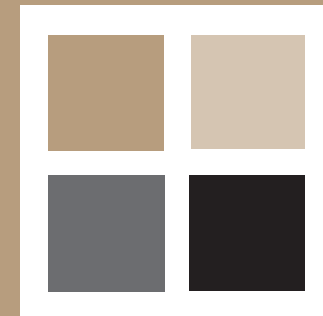

# AN ECO-RESPONSIBLE PROJECT & AN APPROACH CSR

Our partners, suppliers, and subcontractors are chosen based on quality and environmental criteria.

We prioritize local suppliers and subcontractors or those located within the Greater Region (Belgium, France, and Germany) to reduce transport distances and therefore greenhouse gas emissions.

Since its inception, FAIRFAIR has always invested in high-quality, durable equipment. When we invest in equipment, the purchase is carefully considered to serve multiple clients and projects. The products must also minimize waste and promote recycling.



We are committed to sustainable business development, growing steadily and step by step.

At FAIRFAIR, we listen to our employees, offering flexible working hours tailored to the individual needs of our staff and their families.

We foster a relationship of trust between employer and employee through friendly management and transparent operations.

We regularly organize team-building activities, which encourages employee engagement.

FAIRFAIR also invests in employee development and ongoing training.

Another strength of FAIRFAIR is our clients' satisfaction and loyalty, we guarantee quality service.

We have maintained a client contact list that has remained unchanged since the company's founding in 2012.

The majority of our clients have trusted us for over a decade and appreciate our transparency and responsiveness.

# CLIENTS

THEY TRUST US



# YOUR STAND

## STEP BY STEP.

**EQUIPMENT** DESKS, FURNITURES & DECORATION

---

**TECHNICAL** LIGHT/TRUSS, SOUND, VIDEO, ACCESSORIES

---

**FLOOR** WITH OR WITHOUT RAISED FLOOR

---

**WALLS** FOR INFORMATION, STORAGE OR MEETING ROOM

---

**SIGN** HANGING OR FROM THE GROUND

---

**PERSONALIZATION & HIGHLIGHTS** CUSTOM-MADE

*\* The prices do not include VAT, build-up/dismantling & delivery  
Please ask us for a complete quote*

# FURNITURE

EQUIPMENT & DECORATION

# DESKS

BASIC

85,00€

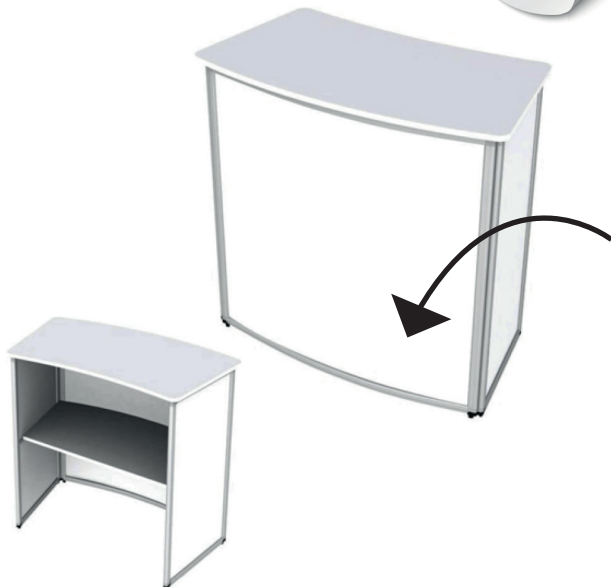

MODULAR  
DESK

CUSTOMIZED THE FRONT PANEL

250,00€

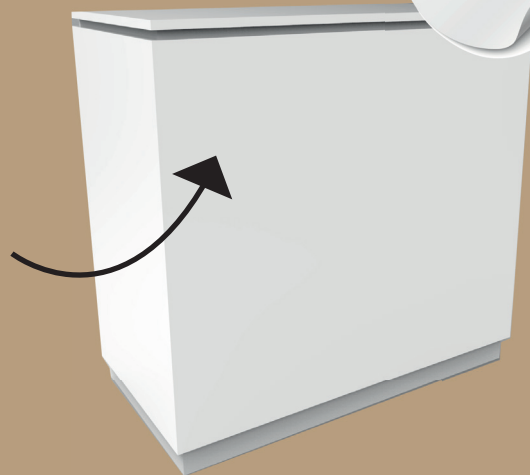

MELA  
DESK

490,00€

SLIT  
DESK



600,00€

ADVANCED  
CUSTOMIZED THE FRONT BACKLIT PANEL



BRIDGE  
DESK

# FURNITURE

EQUIPMENT & DECORATION

# DESKS

WOODEN LATHS



BACKLIT PANEL



FURNITURE



SCREEN



# COMPOSITION IDEAS

# FURNITURE

# EQUIPMENT & DECORATION LOUNGE

24,00€



40,00€



19,00€



80,00€



70,00€



50,00€



69,00€

## SCANDINAVE STYLE



*\* For any other furniture needed, please ask us, much more on demand*

# FURNITURE

# EQUIPMENT & DECORATION LOUNGE

28,00€



42,00€



50,00€



32,00€



64,50€



43,00€



107,00€

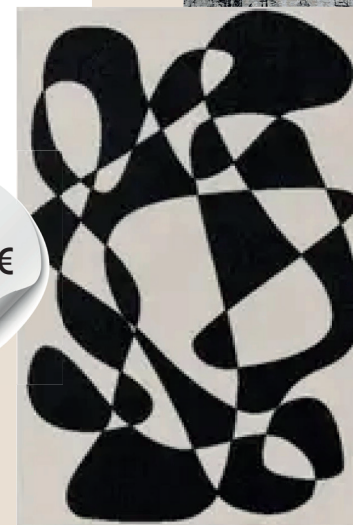

69,00€



50,00€



## MODERN STYLE

# FURNITURE

## EQUIPMENT & DECORATION LOUNGE



**GLAMOUR  
STYLE**

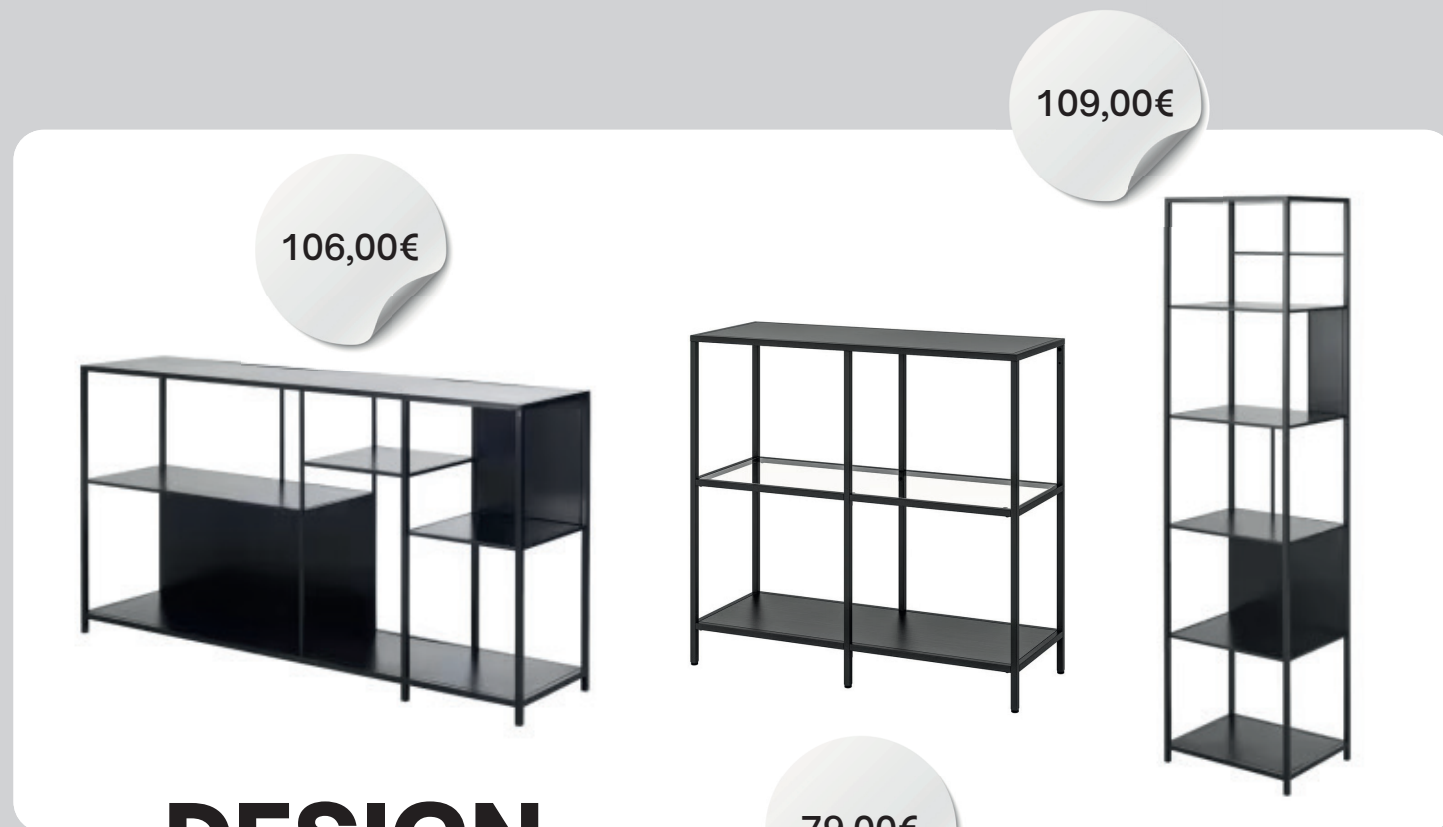

**DESIGN  
STYLE**

# FURNITURE

EQUIPMENT & DECORATION

## KIDS

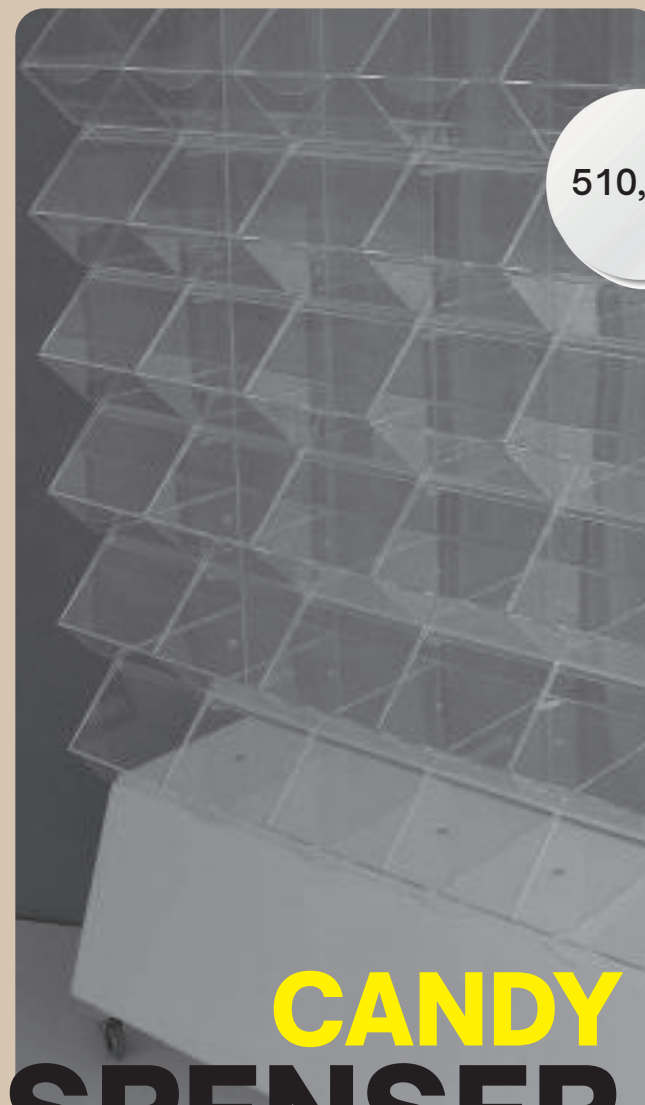
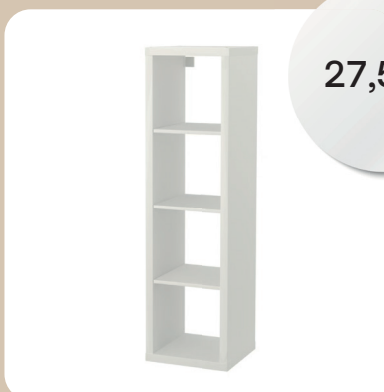

## MINI MOBEL

## CANDY DISPENSER

42,50€

25,00€

27,50€

510,00€

# FURNITURE

EQUIPMENT & DECORATION

# OUTDOOR

164,00€



122,00€



38,00€



11,00€

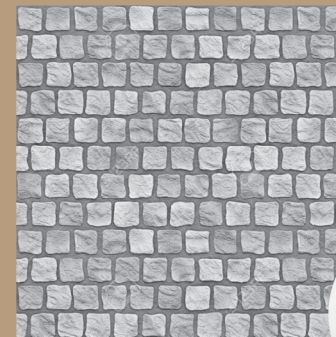

18,00€/m<sup>2</sup>



38,90€/m<sup>2</sup>



55,00€

3 x SEAT  
1 x TABLE  
165,00€

58,00€

3 x SEAT  
1 x TABLE  
174,00€

## CHILL STYLE

# TECHNICAL LIGHT/TRUSS



**BLACK/GREY**  
**TRUSS**



**LIGHT**

# TECHNICAL SOUND



280,00€

SOUND  
SYSTEM

228,00€



PODIUM  
& LECTERN



105,00€

# TECHNICAL VIDEO



250,00€ >  
1150,00€

**INCH**  
32  
40  
50  
65  
98

FREESTANDING OR INTEGRATED IN THE STRUCTURE

55,00€



1820,00€

**TOUCH  
SCREEN**

**IPAD** ON SUPPORT



275,00€

# TECHNICAL ACCESSORIES

THE LARGEST STOCK  
IN LUXEMBOURG  
300 POSTS



SEPARATION  
POTS

25,00€

57,00€

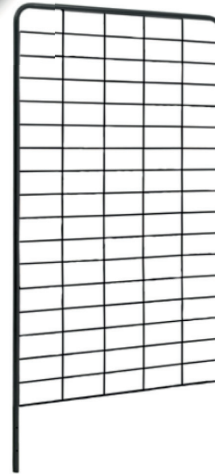

45,00€



23,00€



91,00€



INFOS  
SUPPORTS

# FLOOR FINITION

RAISED FLOOR



15,00€/m<sup>2</sup>

## PARQUET

WOOD / GREY TILES



15,00€/m<sup>2</sup>

## VINYL

PATTERN / COLOR



18,00€/m<sup>2</sup>

## CARPET

THIN / THICK



9,00€/m<sup>2</sup>

## ECO WOOD



11,00€/m<sup>2</sup>

# FLOOR TECHNOLOGY

YOU CAN  
WALK  
ON  
IT

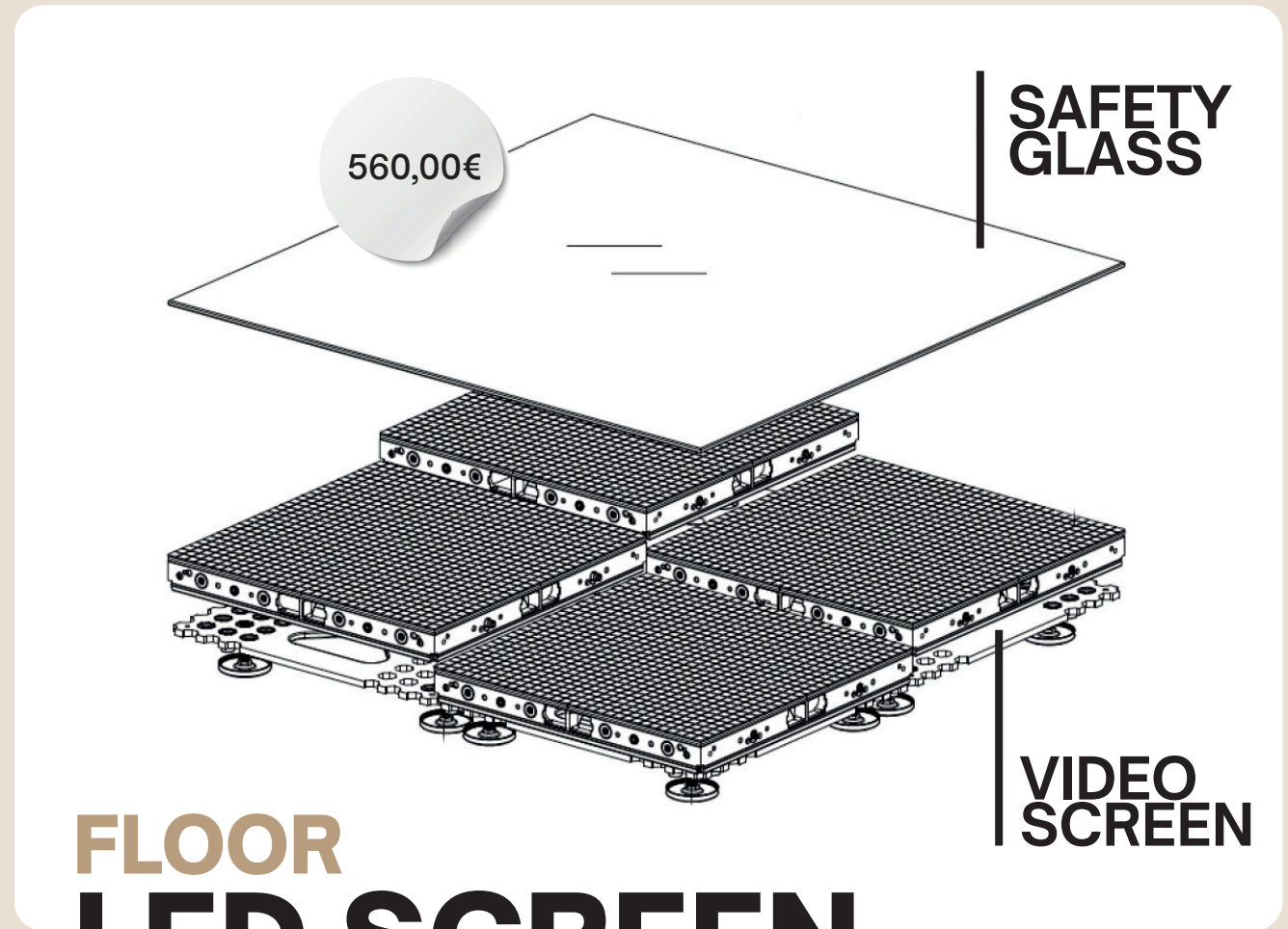

**FLOOR  
LED SCREEN**

# WALLS MODULAR

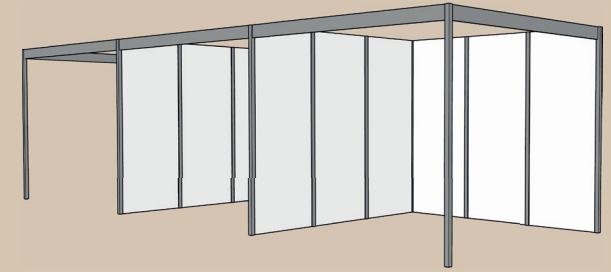

OR TO DEFINE  
SPACES FOR  
AN EVENT ?



20,00€/m



# WALLS

FOR INFORMATION OR STORAGE

# PARTITIONS



IN NEED SOME  
STRUCTURES FOR  
AN EXHIBITION ?



65,00€/m

# WALLS

FOR INFORMATION OR STORAGE

# THE TOWER

A SIGN AT 5.00m  
HIGH WITHOUT ANY  
SUSPENSIONS



2088,00€



1044,00€

# WALLS

FOR A MEETING ROOM

# THE HALF TOWER



1292,00€

IN NEED A COZY PRIVATE SPACE ?

WITH ADJUSTABLE WOODEN  
SLATS AND TRANSPARENT FABRICS



# SIGN

# BACKLIT PANELS

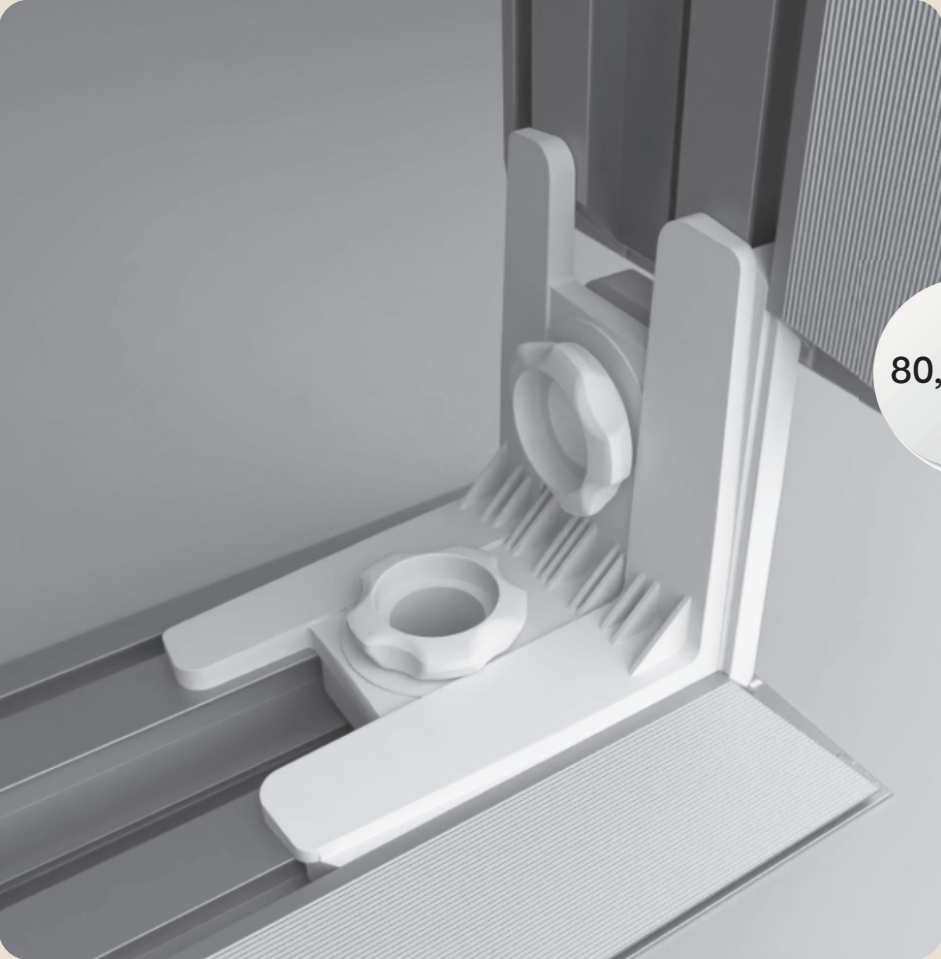

80,00€/m<sup>2</sup>

**TO GIVE YOUR BRAND  
MORE VISIBILITY**



**INNOVATIVE  
HIGH-QUALITY LEDS**

**REUSABLE PRINTS**

**CAN ALSO BE  
TRANSFORMED  
ON TOTE BAG**





**BACKLIT PANELS  
IN VARIOUS SIZES AND TYPES**



# HIGHLIGHT

# THE TUBE

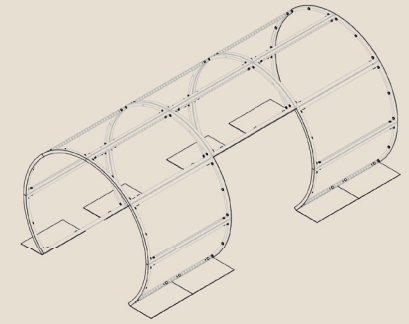

MIRROR  
TUNNEL



1740,00€



# IN NEED SOME IDEAS ?

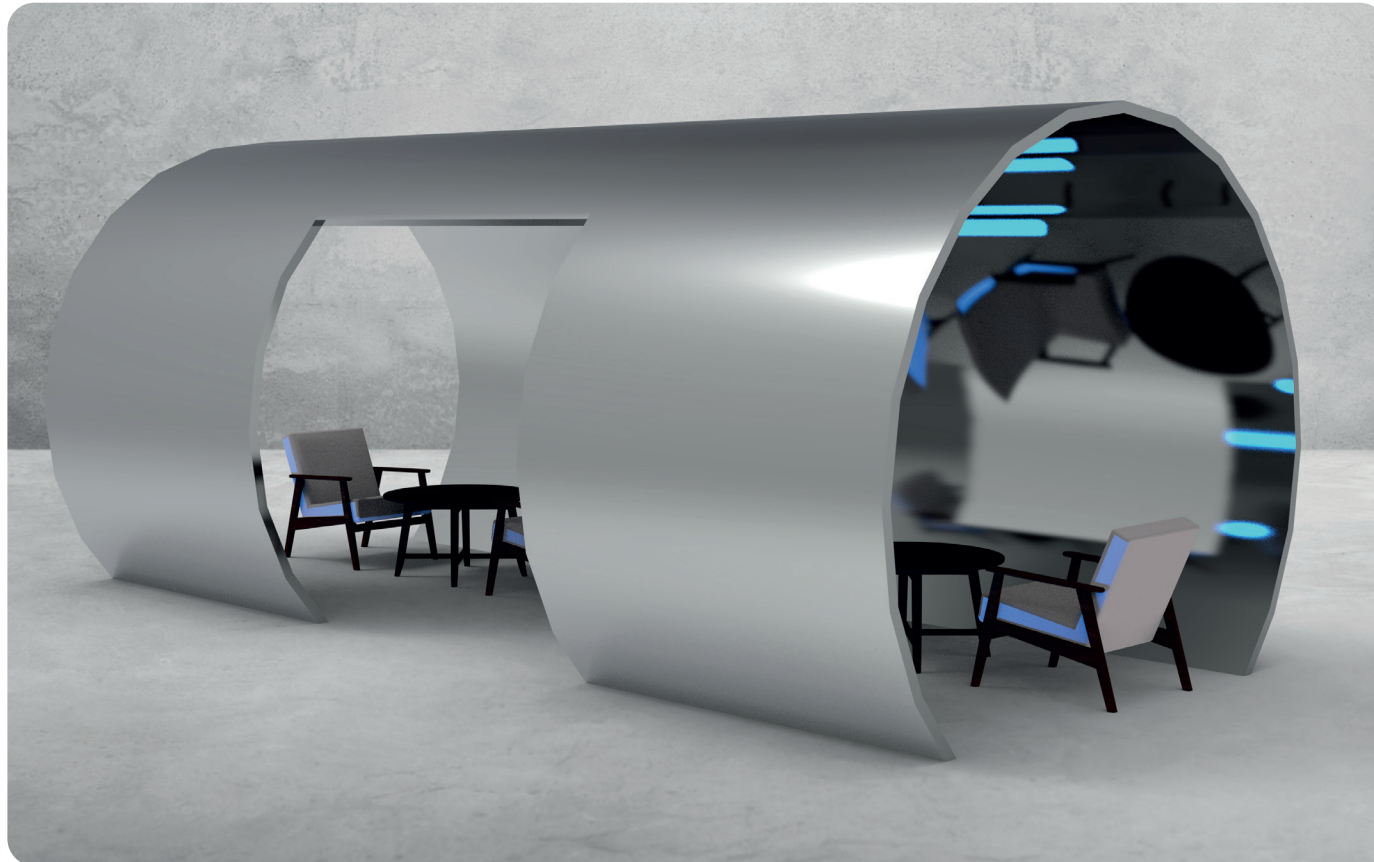

THE TUBE CAN BE COMPLETELY CUSTOMIZED INSIDE AND OUTSIDE TO MATCH THE THEME OF YOUR EVENT

**AS A LOUNGE AREA OR AS THE ENTRANCE FOR YOUR EVENT**



# HIGHLIGHT

# THE CUBE

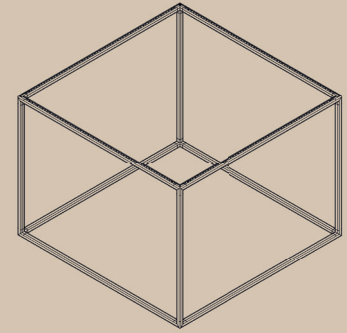

## LIGHT CUBE



2500,00€



# IN NEED SOME IDEAS ?

THE CUBE CAN  
CHANGE THE COLOR  
TO MATCH  
TO YOUR EVENT



**AS A LOUNGE AREA OR AS THE  
ENTRANCE FOR YOUR EVENT**

# PERSONALIZATION

# CUSTOM -MADE



LOUNGE  
FURNITURES  
WOODEN LATHS



# IN NEED AN OUTSIDE BOOTH ? THE PROMOCUBE

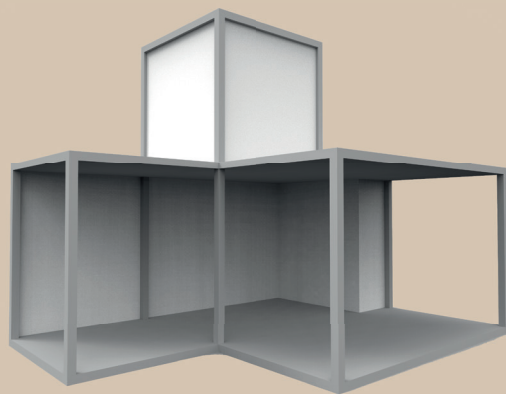

The Promocube offers **complete customization**, allowing your brand to shine from all **360-degree views**.

Its lower covered section creates a cozy space for both **furniture and promotional materials**.

We handle **delivery and installation** at your chosen location and for the duration you need.

DAY 1.900,00€  
WEEK-END 2.800,00€  
WEEK 4.500,00€  
MONTH 12.000,00€



# THANK YOU !

LOOKING FOR A CONTACT ?



[fair@fairfair.lu](mailto:fair@fairfair.lu)



26 84 71 30

DISCOVER OUR PROJECTS  
ON OUR SOCIAL MEDIA



[fairfair\\_lux](#)



[fairfairlux](#)